

## Preparing and mount the panel with standard panel profile.

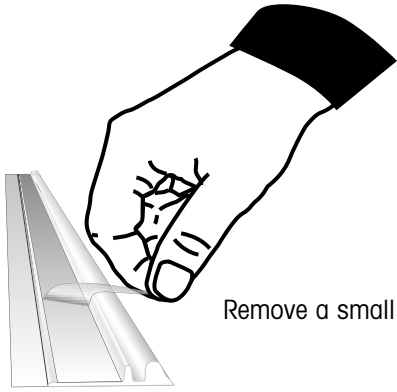

Remove a small part of the protective liner on the fronttape.



Adjust the image towards the strip.

Fix the panelstrip onto the image.

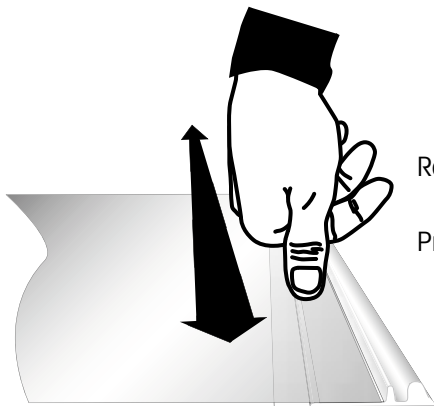
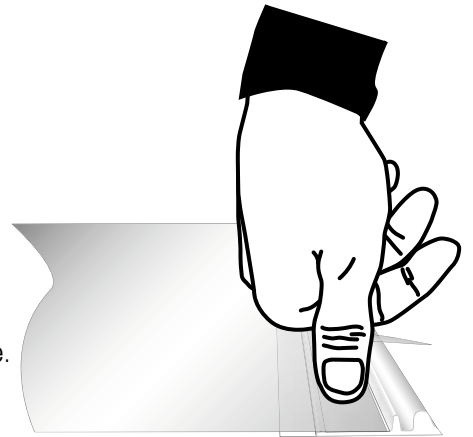

Remove the remaining part of the protective liner.

Press the image firmly onto the panelstrip.

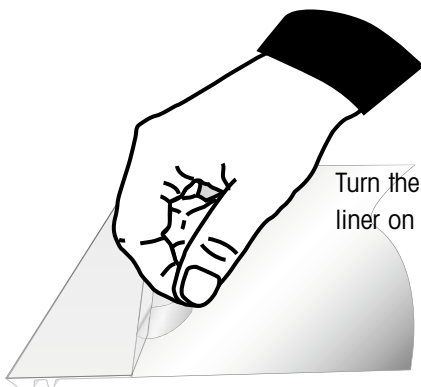

Turn the image around and remove the protective liner on the security tape.

Press the security tape firmly onto the image.

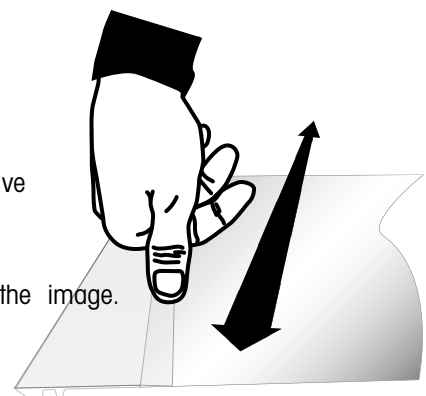

## Preparing and mount the panel with locking panel profile.

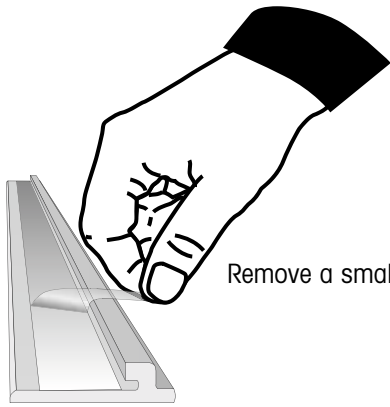

Remove a small part of the protective liner on the fronttape.

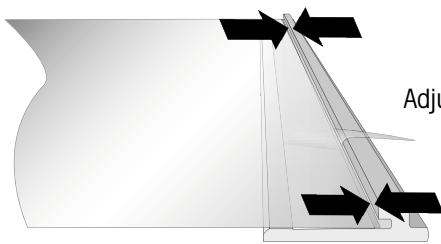

Adjust the image towards the strip.

Fix the panelstrip onto the image.

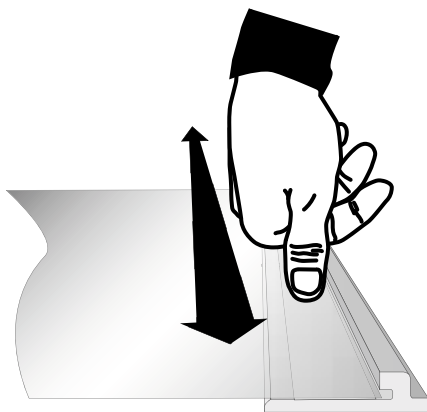
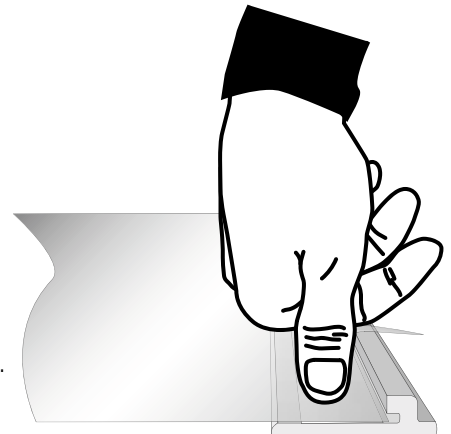

Remove the remaining part of the protective liner.

Press the image firmly onto the panelstrip.

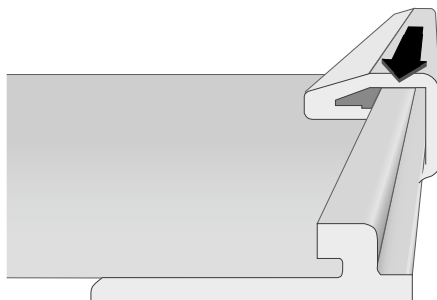

Slide on the top profile onto the image.

Turn the image around and tighten the screws.

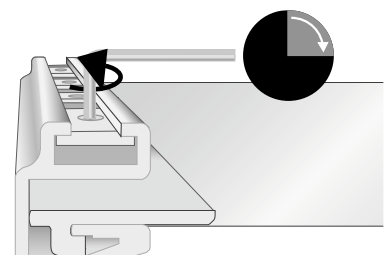

### IMPORTANT!

- Tighten the screw until you meet resistance.
- Tighten further max a quarter of a turn.