

# Panel Guide

## 2023



## CONTENT

ROLL UP CLASSIC .....	3
ROLL UP PROFESSIONAL .....	3
ROLL UP COMPACT .....	3
4 SCREEN CLASSIC .....	3
POLE SYSTEM .....	3
POP UP MAGNETIC.....	4-6
POP UP MAGNETIC TOWER.....	4-5
CASE & COUNTER .....	7
STANDARD CASE.....	7
FABRIC SYSTEM .....	8-9
LIGHT FRAME .....	10-11
CLASSIC FRAME .....	12-14
FABRIC STAND.....	15
MONITOR STAND.....	15
MAGNET FRAME.....	16
PANEL BASE.....	17
STAND UP.....	17
SOFT IMAGE.....	18
SOFT IMAGE COUNTER .....	18
INFO STAND .....	19
PORTABLE TABLE.....	19
BROCHURE STAND.....	19
BROCHURE STAND DOUBLE .....	19
GRAPHIC PROFILE .....	19

VISIT [WWW.EXPOLINC.COM](http://WWW.EXPOLINC.COM) FOR SET-UP MOVIES AND DOWNLOADS

## Roll Up

Product	Panel size standard	Visible size standard	Panel size telescopic rod	Visible size telescopic rod	Weight
<b>Roll Up Classic 700</b>	700 x 2200	700 x 1950	x	x	3,9
<b>Roll Up Classic 850</b>	850 x 2400	850 x 2150	850 x 2490	850 x 1625 - 2240	4,5
<b>Roll Up Classic 1000</b>	1000 x 2400	1000 x 2150	1000 x 2490	1000 x 1625 - 2240	5,2
<b>Roll Up Classic 1150</b>	1150 x 2400	1150 x 2150	1150 x 2490	1150 x 1625 - 2240	5,8
<b>Roll Up Classic 1450</b>	1450 x 2400	1450 x 2150	x	x	7,3
<b>Roll Up Professional 850</b>	850 x 2400	850 x 2150	x	x	4,8
<b>Roll Up Professional Double</b>	850 x 2400	850 x 2150	x	x	7,3
<b>Roll Up Compact 850</b>	x	x	850 x 2420	850 x 1605 - 2200	3,4
<b>Roll Up Compact 1000</b>	x	x	1000 x 2420	1000 x 1605 - 2200	3,7

Maximum panel thickness is 440 micron. When using 2450 mm supporting rod or stiff material, the recommended thickness is 270-330 micron. When using 2450 mm supporting rod add 300 mm to the panel size. If uncertain we recommend to make tests with different materials.

## 4 Screen Classic

Product	Panel size	Visible size	Weight
<b>4 Screen Classic 550</b>	550 x 1495	550 x 1481	1,9
<b>4 Screen Classic 700</b>	700 x 1960	700 x 1946	2,2
<b>4 Screen Classic 850</b>	850 x 2160	850 x 2146	2,5
<b>4 Screen Classic 1000</b>	1000 x 2160	1000 x 2146	2,7
<b>4 Screen Classic 1150</b>	1150 x 2160	1150 x 2146	4,1
<b>4 Screen Classic 1450</b>	1450 x 2160	1450 x 2146	4,7
<b>4 Screen Classic 2000</b>	2000 x 2160	2000 x 2146	5,3

4 Screen can handle most materials up to 450 micron thickness (paper, vinyl, pvc, textile). When using 2450 mm supporting rod add 300 mm to the panel size.

## Pole System

Product	Panel size width	Panel size height	Weight
<b>Pole System 550</b>	550	optional, max 2400	2,6
<b>Pole System 700</b>	700	optional, max 2400	2,7
<b>Pole System 850</b>	850	optional, max 2400	2,8
<b>Pole System 1000</b>	1000	optional, max 2400	2,9

Pole System can also be used as double sided. In this case an extra panel profiles should be added. Pole System can handle most materials up to 450 micron thickness (paper, vinyl, pvc, textile). Total height of the system is min 1000 mm and maximum 2560 mm.

## Panel profile dimension sketch

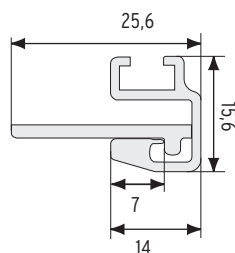

## Pop Up Magnetic - panel sizes

### Curved system

Product	Standard height	2,5 m height	3 m height
Curved, inside	673x2224	673x2485	673x2957
Curved, outside	808x2224	808x2485	808x2957
Side panel, curved	673x2224	673x2485	673x2957
Side panel, straight	293x2224	293x2485	293x2957

### Straight system

Product	Standard height	2,5 m height	3 m height
Straight panel	733x2224	733x2485	733x2957
Side panel, curved	733x2224	733x2485	733x2957
Side panel, straight	293x2224	293x2485	293x2957

### Connected systems

Product	Standard height	2,5 m height	3 m height
Straight connection	733x2224	733x2485	733x2957
90° connection with panel, inside	265x2224	265x2485	265x2957
90° connection with panel, outside	733x2224	733x2485	733x2957
90° connection with profile, outside	531x2224	531x2485	531x2957

## Pop Up Magnetic - weights

Product	Basic		Travel		Standard		Case & Counter*		Top shelf
	Curved	Straight	Curved	Straight	Curved	Straight	Curved	Straight	C&C
Package 2x3	8,5	8,8	15,5	15,8	23,0	23,3	26,5	26,8	5,3
Package 3x3	10,4	10,8	18,0	18,4	25,5	25,9	29,0	29,4	5,3
Package 4x3	12,3	12,8	20,0	23,5	27,5	28,0	31,0	31,5	5,3

\*The top shelf is not included in the Case & Counter package.

## Pop Up Tower

Product	Qty panels	Panel size	Diameter	Weight
Tower 3 squares high	3 pcs	673x2224	643	5,5

Tower panel thickness should be 350 - 420 micron, as they should be pliable. These panels should not have kickers.

## Pop Up Magnetic - accessories

Product	Standard height + recommended width
Curtain	2215 x 1300

Product	Maximum load straight system	Maximum load curved system	Weight
Screen Holder	6,00*	8,00	1,1
Shelf Kit	4,65*	6,65	2,4

\* Stabilizing feet code 7365 should be used for straight system. Screen Holder and Shelf Kit may only be used with Expolinc Pop Up Magnetic.

## Pop Up Magnetic - dimension sketches

### Example 3 squares

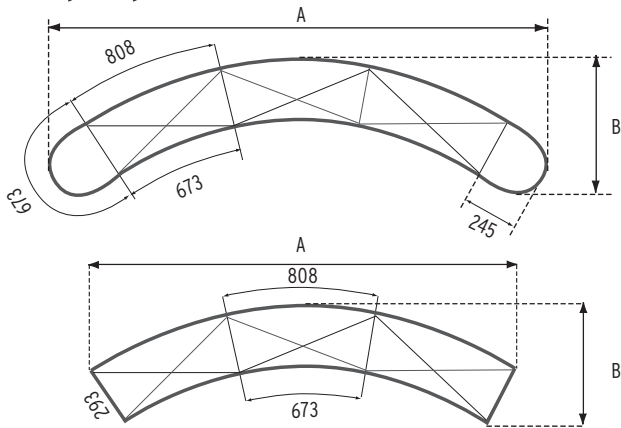

### Curved system

Width	Curved side panels		Straight side panels	
	A	B	A	B
1 square	1225	375	846	350
2 squares	1915	510	1607	461
3 squares	2535	710	2290	639
4 squares	3065	970	2860	877
5 squares	3600	1250	3289	1161

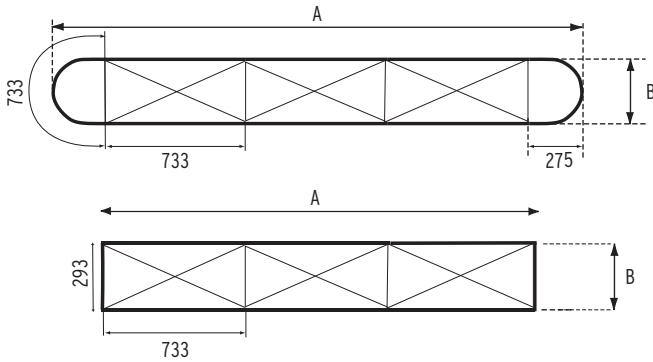

### Straight system

Width	Curved side panels		Straight side panels	
	A	B	A	B
1 square	1283	315	779	315
2 squares	2016	315	1512	315
3 squares	2749	315	2245	315
4 squares	3482	315	2978	315
5 squares	4215	315	3711	315

### Straight connection

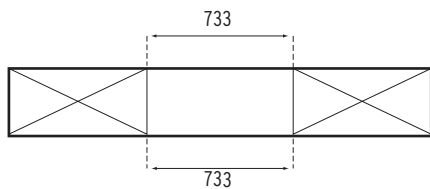

### 90° connection with panel

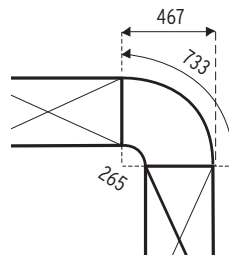

### with profile

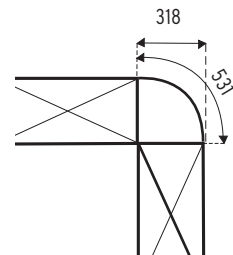

### Radius

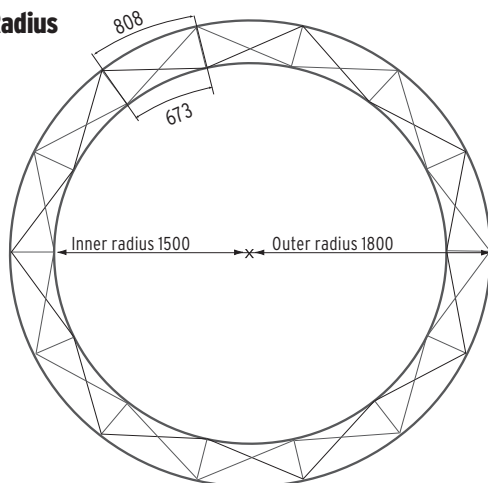

### Tower

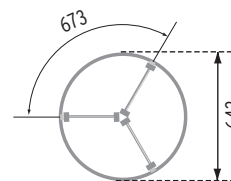

## Screen Holder & Shelf kit

### Position of holes in panel for Screen Holder/Shelf kit

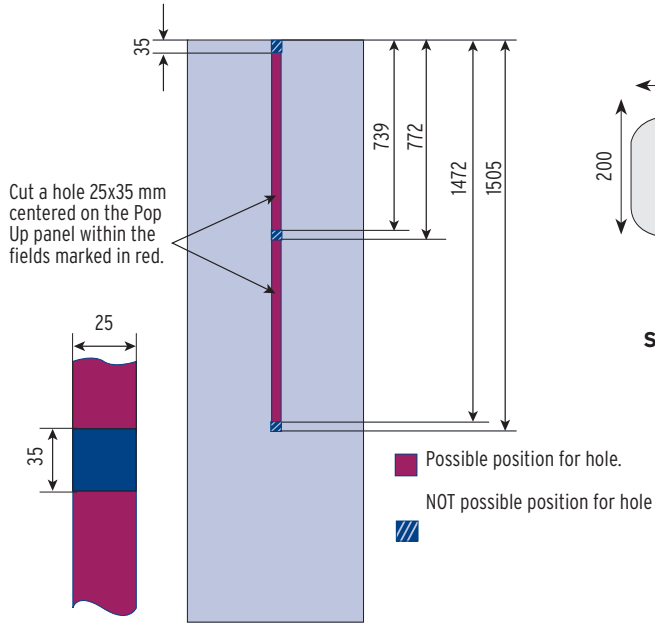

### Shelf Kit

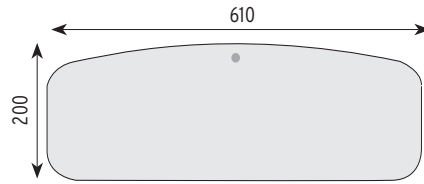

### Screen plate & VESA 100 & 200 Hole spacing

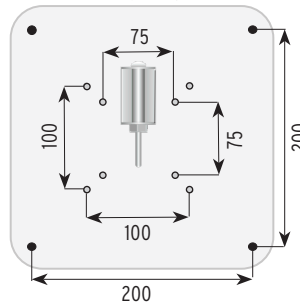

### Screen Holder

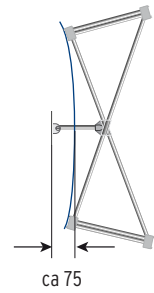

### Suspension options

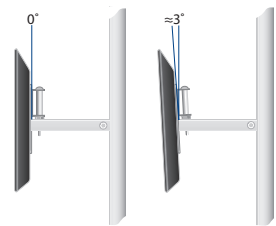

## Showcase

### Standard height

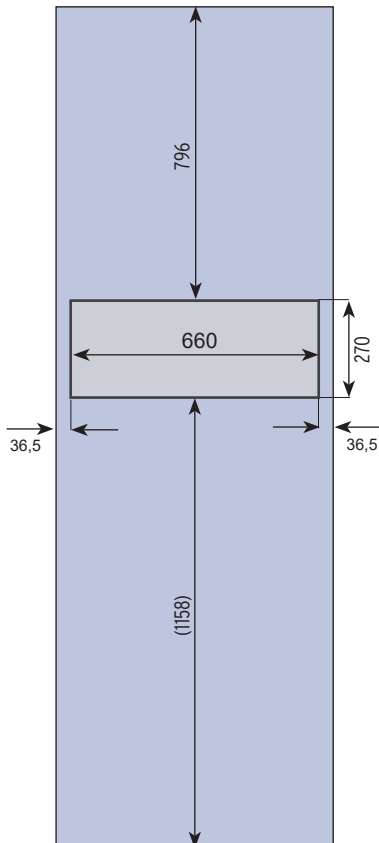

### 2,5 m height

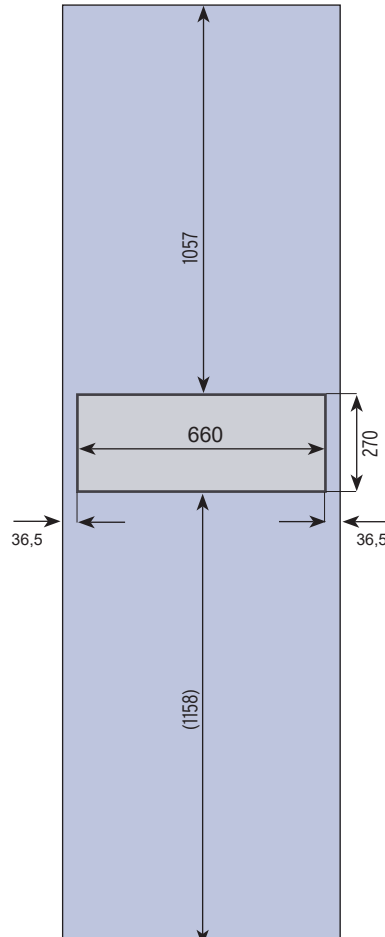

### Panel size - backpanel

**Minimum size 733x320**  
Also add the required quantity of magnetic bars for the backpanel.

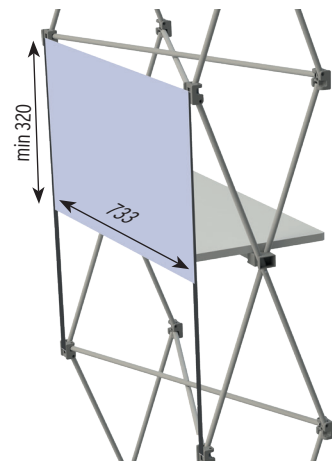

## Transport boxes

Product	Panel size	Weight
<b>Case &amp; Counter</b>	1820 x 920	16,5*
<b>Double Case &amp; Counter</b>	2880 x 920	33*
<b>Standard Case</b>	1585 x 840	10,8

\*Top shelf is not included in Case & Counter. Weight top shelf 5.3 kg, top shelf double Case & Counter 7.3 kg.  
Recommended panel thickness 350 - 420 micron.

### Case & Counter

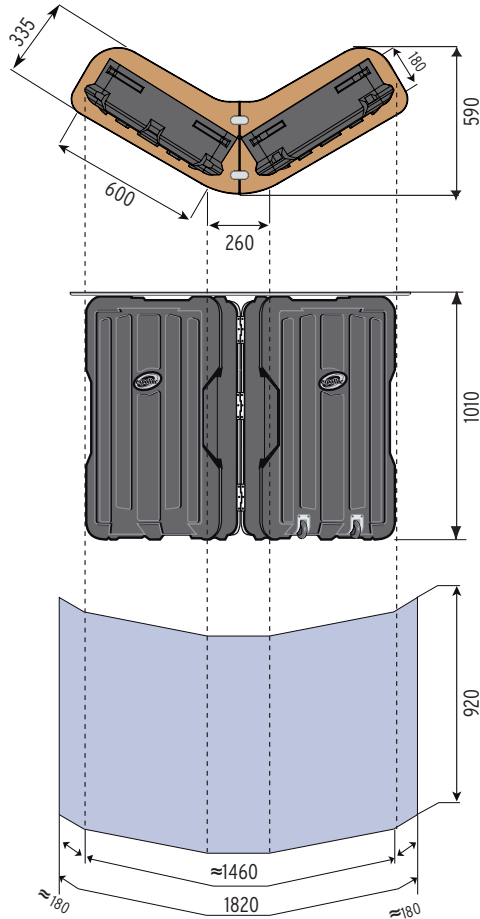

### Standard Case

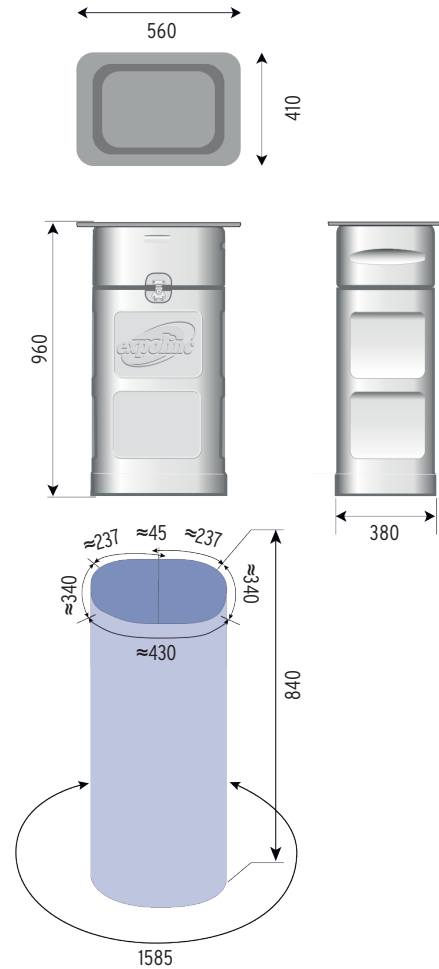

### Double Case & Counter

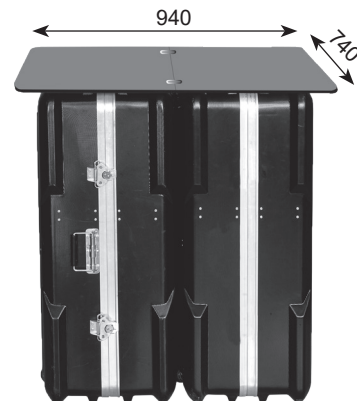
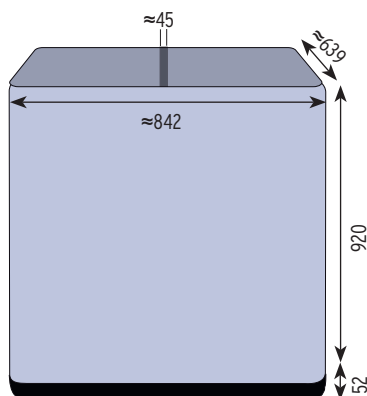

## Fabric System

Product	Max building width mm	Graphic height mm	Graphic width mm
<b>2 Poles straight</b>	3300	1000 - 2750	Profile lengths+sides
<b>2 Poles curved 15°</b>	3300	1000 - 2750	Profile lengths+sides
<b>3 Poles curved 15°</b>	6600	1000 - 2750	Profile lengths+sides
<b>3 Poles straight</b>	6600	1000 - 2750	Profile lengths+sides
<b>3 Poles curved 90°+straight</b>	6800	1000 - 2750	Profile lengths+sides

Max system height 2900 mm

### Profile lengths

<b>Straight profile, can be cut into desired length</b>	<b>1100</b>
<b>Curved profile 15°, inner radius</b>	1100
<b>Curved profile 15°, outer radius</b>	1100
<b>Curved profile 90°, inner radius</b>	1300



**Curved profile 15° 1100 mm**  
Graphic on outer radius 4,2 m.



**Curved profile 15° 1100 mm**  
Graphic on inner radius 4,2 m.



**Straight profile 1100 mm**  
Can be cut into desired length.

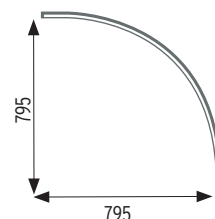

**90° inner curve 1300 mm**  
Graphic on inner radius 0,8 m.

Weight packages	Weight*
<b>Soft bag and 2 poles</b>	16,50
<b>Standard Case XL and 2 poles</b>	29,00
<b>Standard Case XL and 3 poles</b>	35,00
<b>Profiles, straight and curved 15°</b>	0,50
<b>Profile curved 90°</b>	0,55

\*Weight excl profiles. Combine packages for larger building widths.



Recommended size of the graphic strip is 3x12mm in soft PVC or silicone.



Add 100 mm on each side to fold sides + seams at the top and bottom.

## Standard Case XL

Product	Panel size	*Weight kg	Weight top shelf
<b>Standard Case XL</b>	1585 x 840	11,5	2,5 kg
<b>Standard Case XL</b>	1585 x 1075 with lid	11,5	2,5 kg

Recommended panel thickness 350 - 420 micron. \*Top shelf, locking kit and papertube for panel are not included in Standard Case XL.

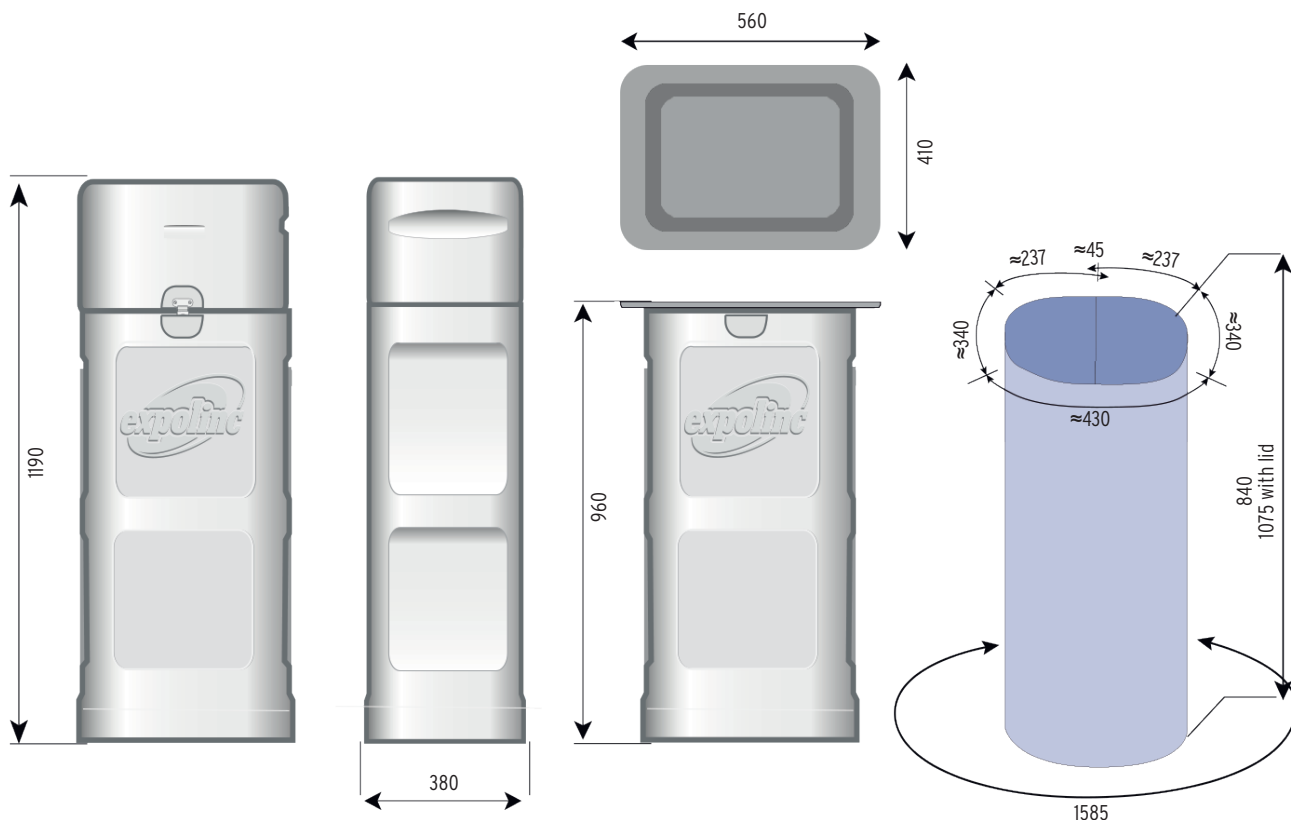



## Some examples

Top and bottom profiles



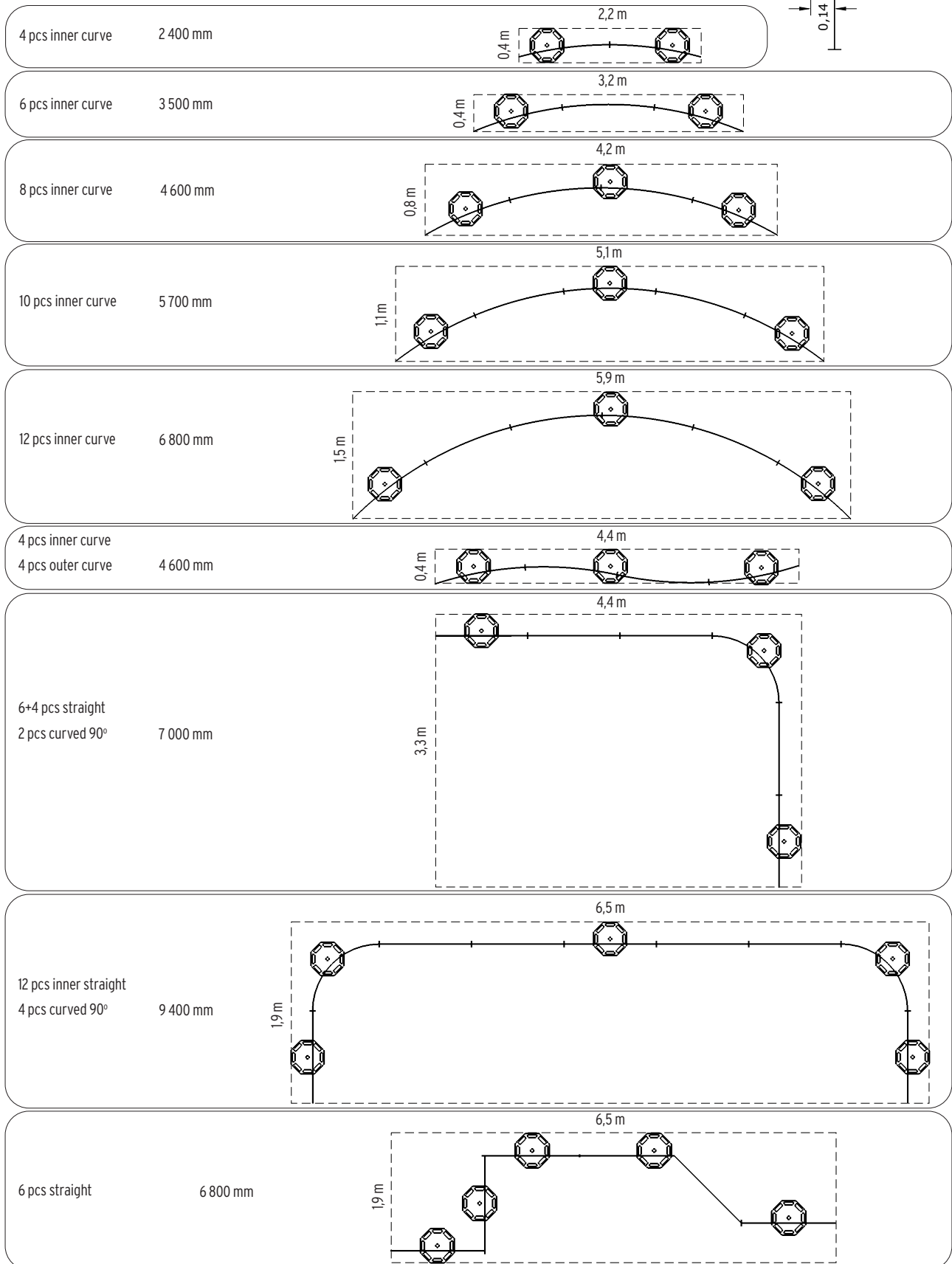
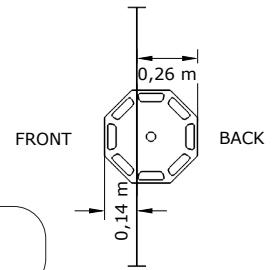

Graphic width inl 10 mm on each side

Total curve 30-45-60-75  
resp 90 degrees



# LIGHT Frame

## Profiles

<b>Light Profile</b>		875 mm
<b>Profile 553</b>		553 mm
<b>Profile 803</b>		803 mm
<b>Profile 969</b>		969 mm

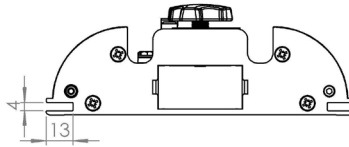

## Packages

**Weight**  
Basic/Standard Case/Travel

<b>962x2495</b>	28,5/N/A/27,3
<b>1937x2495</b>	35,4/40,2/33,5
<b>2712x2495</b>	42,5/46,2/39,5
<b>3587x2495</b>	50/53,1/46,4

Recommended max size for silicone or pvclist 14 x 3 mm

## Graphic sizes - frame outer measurements

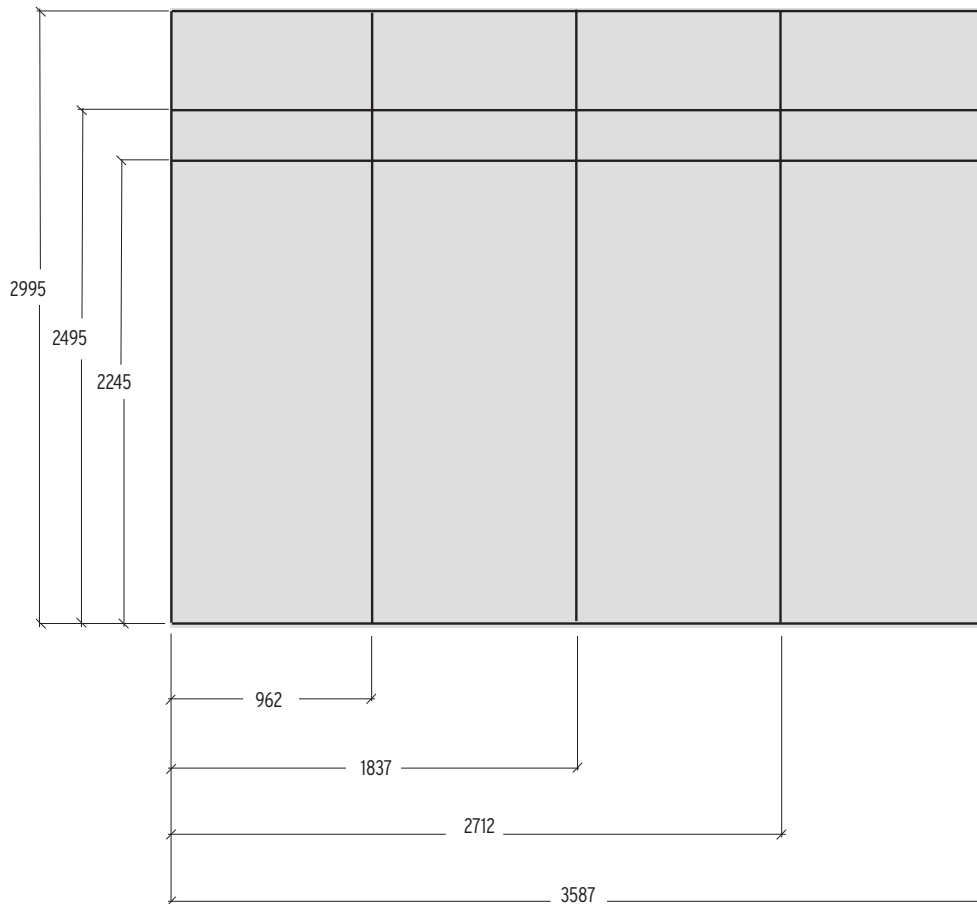

## Examples

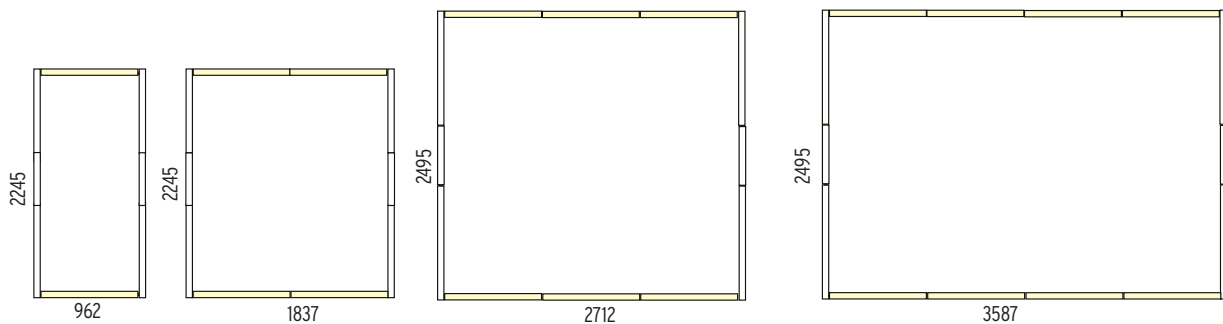

## Connectors

45 mm of the graphic will be hidden when connecting Frames in 90°.

Type A - Frame/Light Frame

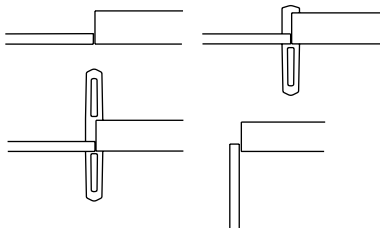

Type B - Light Frame/Frame

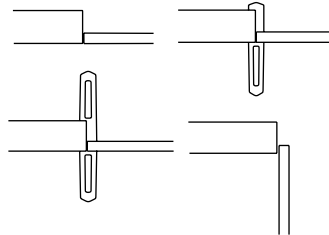

Light Frame/Light Frame

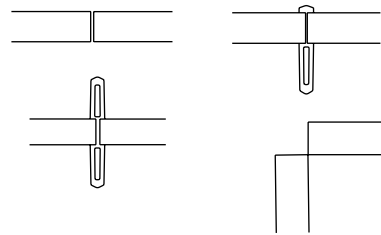

## Example - graphic sizes

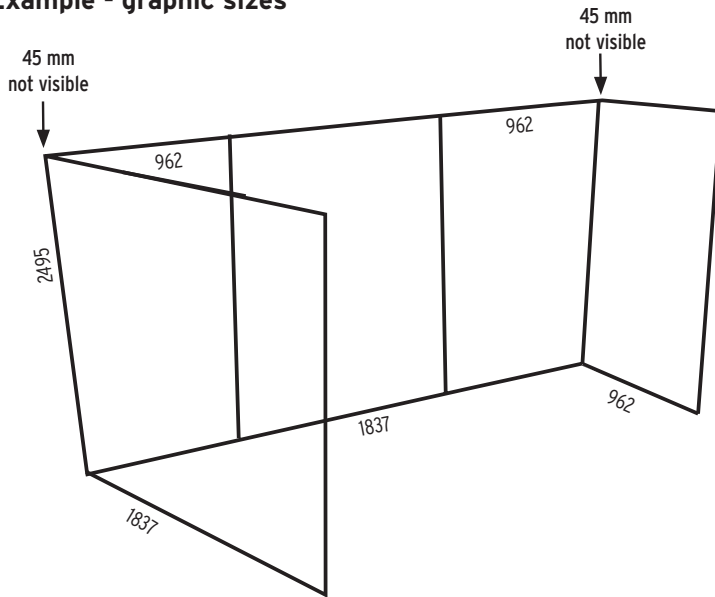

### Content

- 2 pcs 1837x2495
- 3 pcs 962x2495
- 2 pcs Connector 90°
- 2 pcs Connector straight,

## Stabilising feet

Product	Weight
Double sided foot, pair (right and left)	4,1
Double sided foot, single	2,1
Single sided foot, pair (right and left)	3,4
Single sided foot, left	1,7
Single sided foot, right	1,7
Double sided connecting foot	2,1
Single sided connecting foot	1,7

## Supporting feet, double sided and single sided

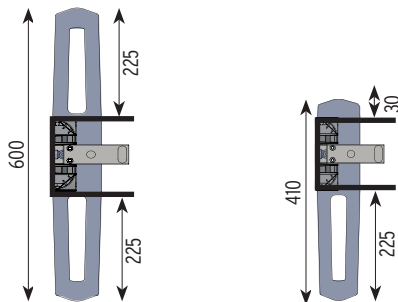

## Connecting feet, double sided and single sided

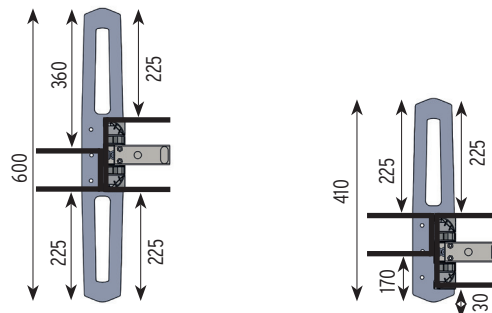

## Classic Frame

### Profiles

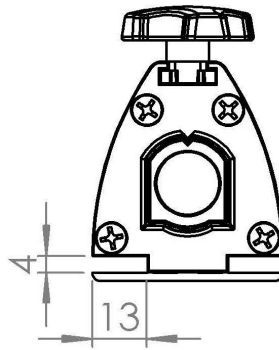
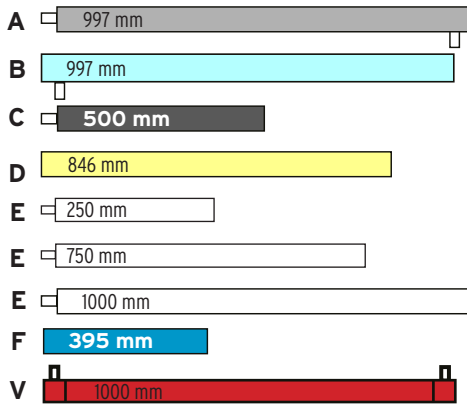

### Packages

Weight  
Basic/Travel/Standard Case XL

Packages	Weight
500x2495	9,5/NA/NA
950x2495	10,4/NA/NA
1950x2495	13,4/15,9/23,9
2950x2495	16,5/19,0/27,0
3950x2495	20,4/22,9/30,9
4950x2495	25,0/27,5/35,5

Recommended max size for silicone or pvclist 14 x 3 mm

### Graphic sizes - frame outer measurements

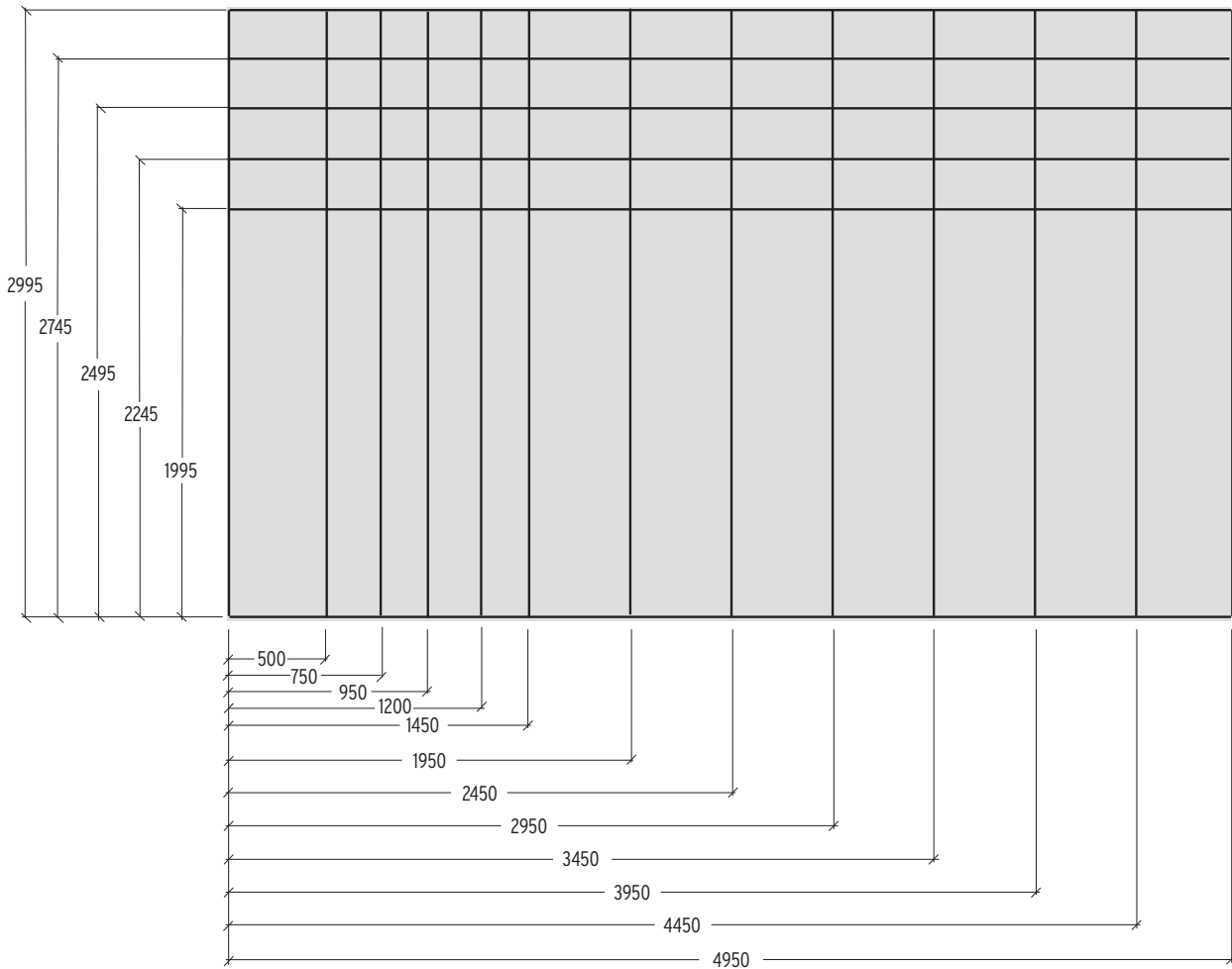

### Examples

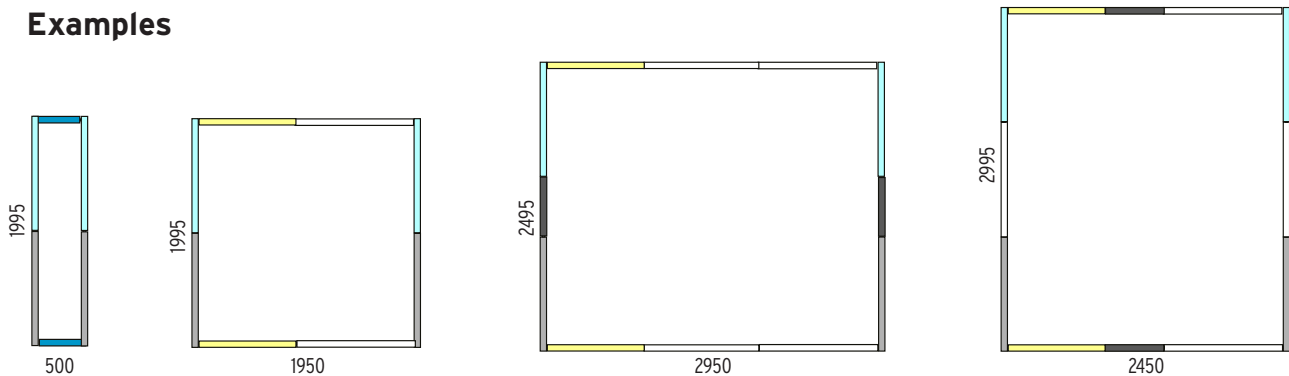

## Connectors

With connectors A-C 45 mm of the graphic will be hidden behind the connecting profile.

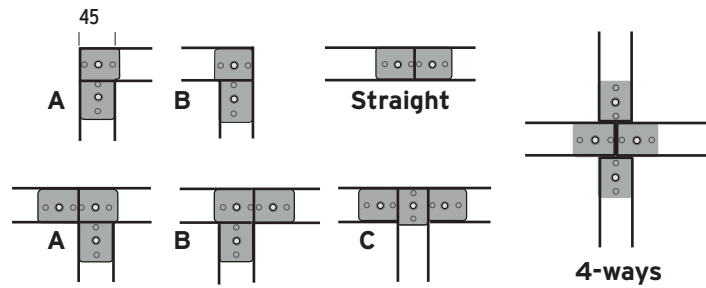

## Example - Frame outer measurements

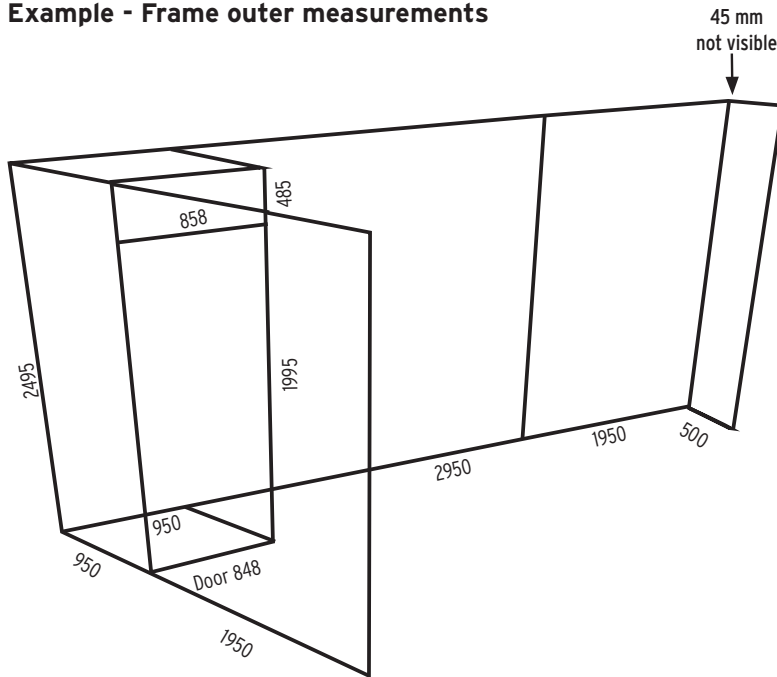

### Content

- 2 pcs 1950x2495
- 1 pc 2950x2495
- 1 pc 500x2495
- 1 storage room, left hung door
- Connector 90° type B

## Stabilising feet

Product	Weight
Single sided foot	1,30
Double sided foot	1,80
Connecting foot, single sided incl upper straight connector	1,35
Connecting foot, double sided incl upper straight connector	1,85

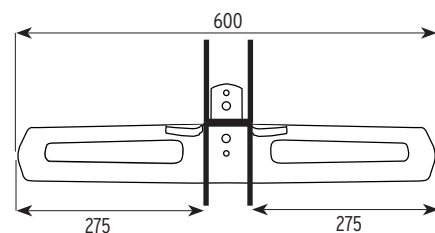
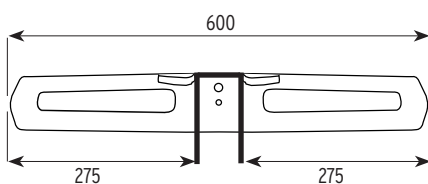
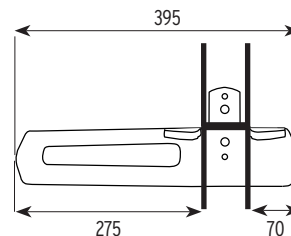
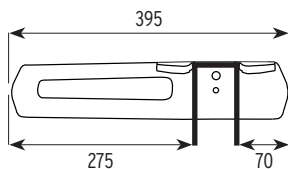

## Classic Frame - Storage room

Product	Weight
Storage Room - Standard 2500mm	47
Storage Room - Standard 3000mm	55
Storage Room - XL 2500mm	63
Storage Room - XL 3000mm	69

### Storage Room - Standard - Outer frame sizes

2500mm - Side	950 x 2495
2500mm - Door	848 x 1995
2500mm - Header above door	858 x 485
3000mm - side	950x2995
3000mm - Door	848x1995
3000mm - Header above door	858x985

#### Standard 2500mm

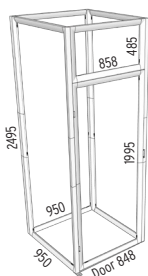

#### Standard 3000mm

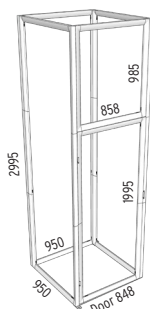

#### XL 2500mm

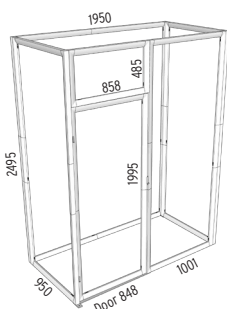

#### XL 3000mm

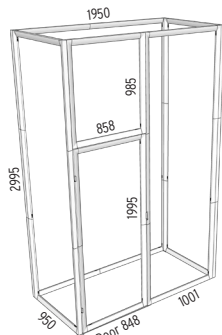

### Storage Room - XL - Outer frame sizes

2500mm - Side	950 x 2495
2500mm - Side	1001 x 2495
2500mm - Side	1950 x 2495
2500mm - Door	848 x 1995
2500mm - Header above door	858 x 485
3000mm - Side	950 x 2995
3000mm - Side	1001 x 2995
3000mm - Side	1950 x 2995
3000mm - Door	848 x 1995
3000mm - Header above door	858 x 985

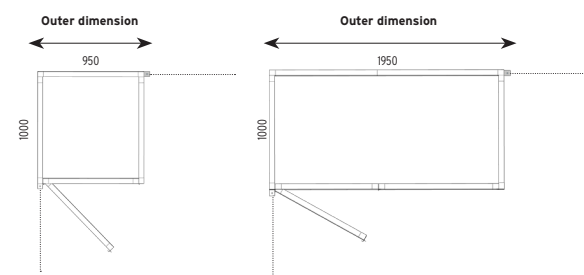

## Classic Frame - Counter

Product	No of graphics	Outer frame sizes	Weight*
Classic Frame - counter, 2 m in Standard Case XL	1 pc front	1950x988	44
	2 pcs sides	338x988	
Classic Frame - counter, 1 m in Standard Case XL	1 pc front	950x988	33,5
Classic Frame - counter, 1 m in Soft Bag	1 pc front	950x988	24,5
	2 pcs sides	338x988	

\*Weight incl. Standard Case XL.

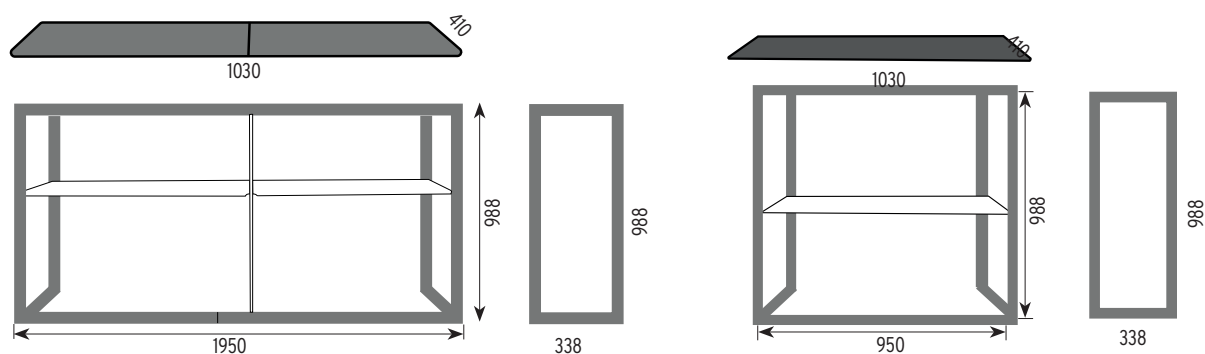

## Fabric Stand

Product	Frame outer measurements	Weight
Fabric Stand with feet	996 x 1996	4,6
Fabric Stand with flat base	996 x 1996	6,1

Graphic size - frame outer measurements

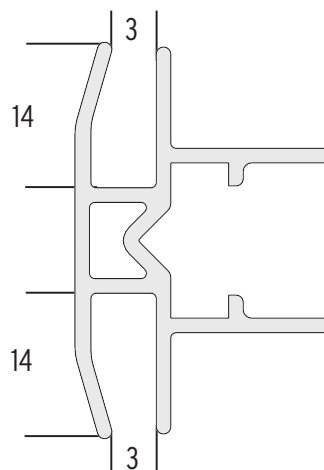
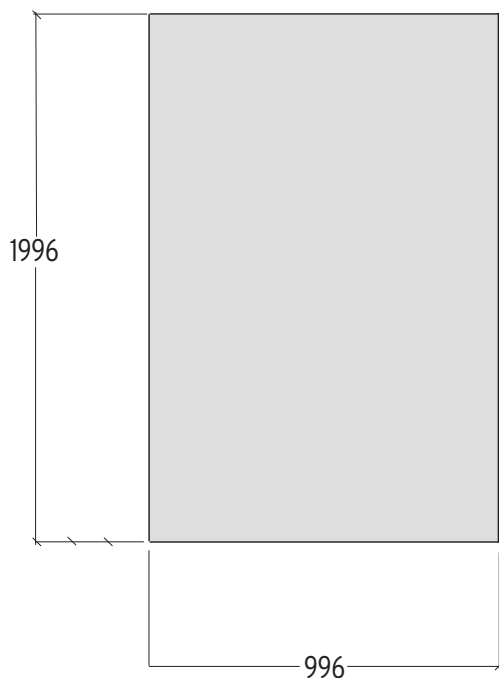

**Recommended max size for silicone or pvc list 14 x 3 mm**

## Monitor Stand

Product	Max screen weight	System height	Weight
Monitor Stand	15 kg (about 55" today)	1810 mm	14 kg

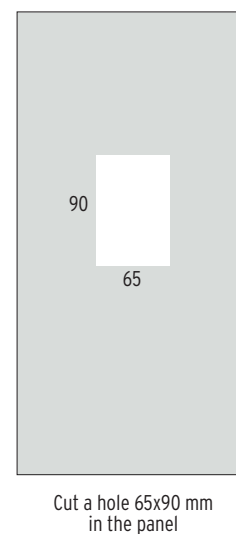
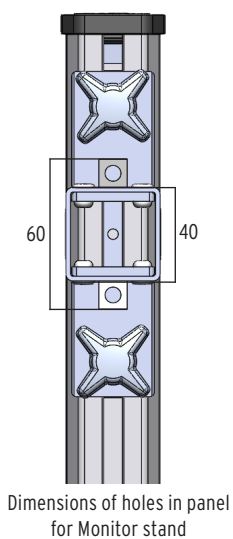
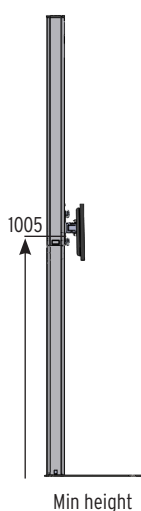
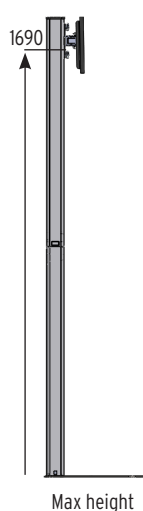

## Magnet Frame

Product	Art No	Panel size	Weight
<b>400 x 1600</b>	6451	400 x 1585	2,9
<b>610 x 1800</b>	6454	610 x 1785	3,8

Recommended panel thickness 350x420 micron. 2 panels for double sided system.

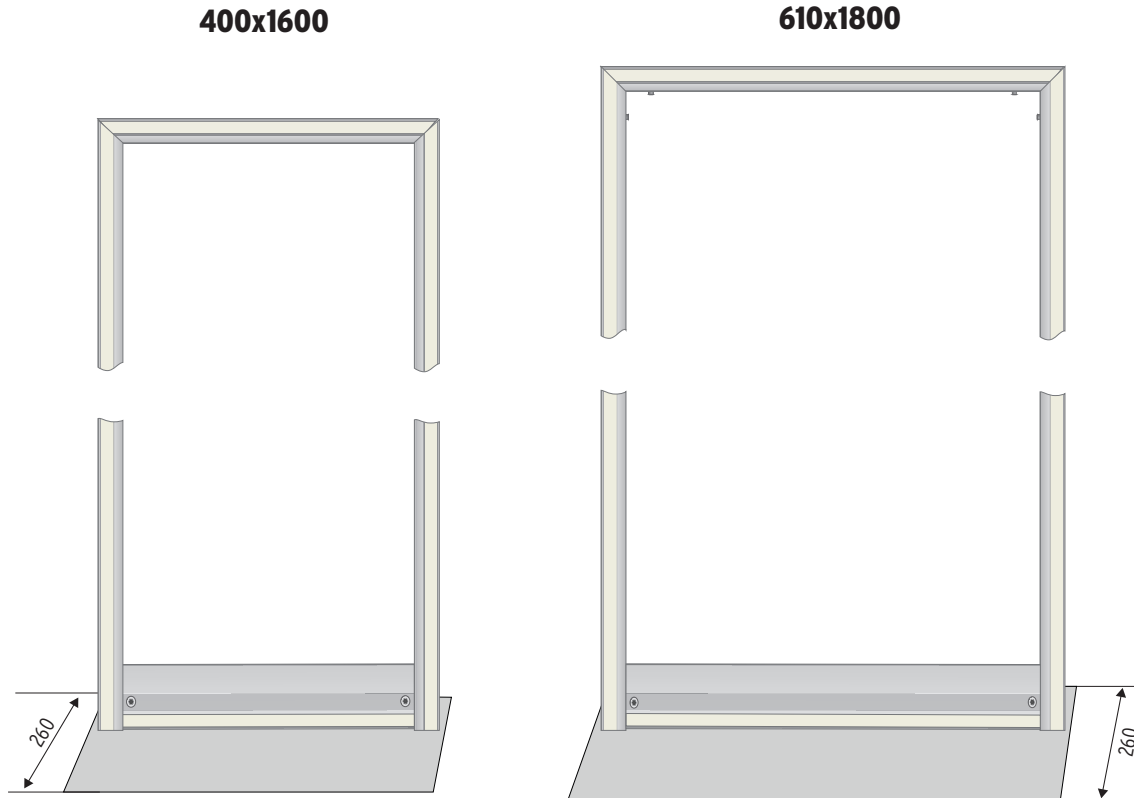

## Magnet Frame with Flat Base (purchased 2020 or earlier)

Product	Panel size	Weight Flat Base	Weight Magnet Frame
<b>400 x 1600</b>	400 x 1585	1,1	1,8
<b>400 x 1800</b>	400 x 1785	1,1	1,9
<b>610 x 1600</b>	610 x 1585	1,7	2,0
<b>610 x 1800</b>	610 x 1785	1,7	2,1

Recommended panel thickness 350x420 micron. 2 panels for double sided system.

## Magnet Frame with Panel Base (purchased 2020 or earlier)

Product	Panel size	Weight Panel Base	Weight Magnet Frame
<b>400 x 1600</b>	400 x 1535	1,7	1,8
<b>400 x 1800</b>	400 x 1735	1,7	1,9
<b>610 x 1600</b>	610 x 1535	2,5	2,0
<b>610 x 1800</b>	610 x 1735	2,5	2,1

Recommended panel thickness 350x420 micron. 2 panels for double sided system.



## Panel Base

Product	Qty panels	Max panel thickness	Weight
<b>Panel Base 80 (pair)</b>	1 pc	19	0,7
<b>Panel Base 400</b>	1 pc	19	1,7
<b>Panel Base 610</b>	1 pc	19	2,5
<b>Panel Base 1220</b>	1 pc	26*	7,2

Panel Base can handle most materials up to 19 mm thickness. Recommended max panel height ca 1800 mm depending on the material.  
Please note that 50 mm at the bottom will be invisible in the systems L-extrusion.

### Panel Base 80



### Panel Base 400

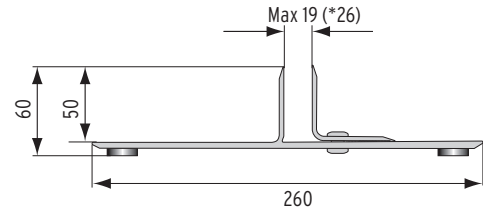
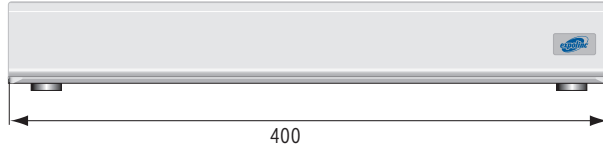

### Panel Base 610/1220

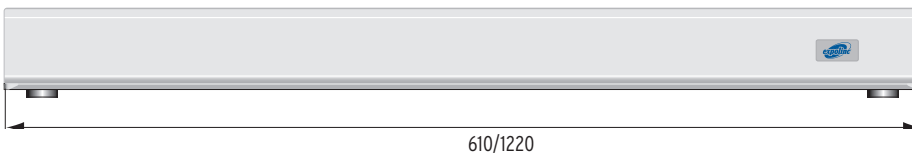

## Stand Up

Product	Qty panels		Panel size	Visible size	Weight
<b>Universal Counter</b>	1 pc	Front	700 x 950	690 x 940	17,5
	4 pcs	Sides	285 x 950	275 x 940	
<b>Info Counter</b>	1 pc	Front	700 x 950	690 x 940	9,5
	2 pcs	Sides	285 x 950	275 x 940	

Maximum panel thickness 7 mm. Use clips in thickness <5 mm.

### Stand Up Universal Counter

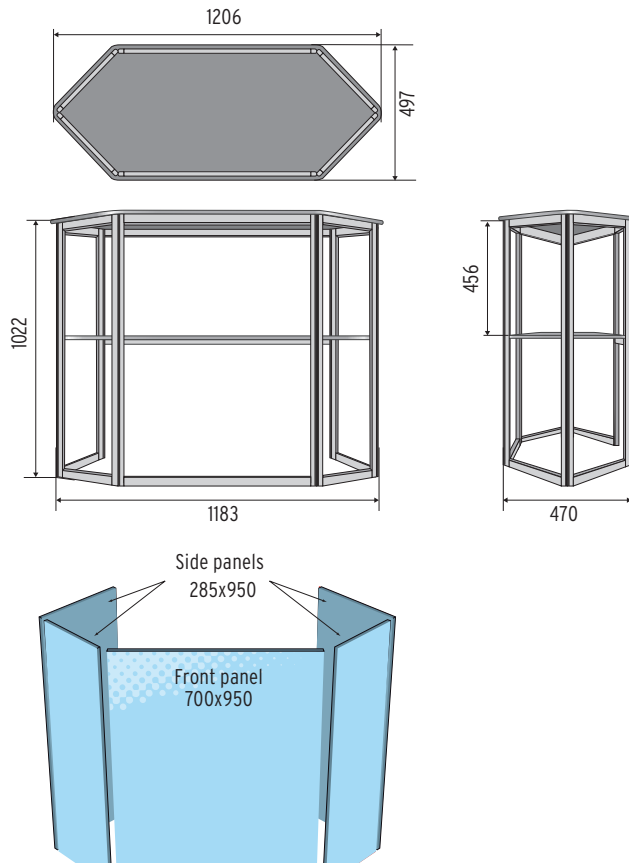

### Stand Up Info Counter

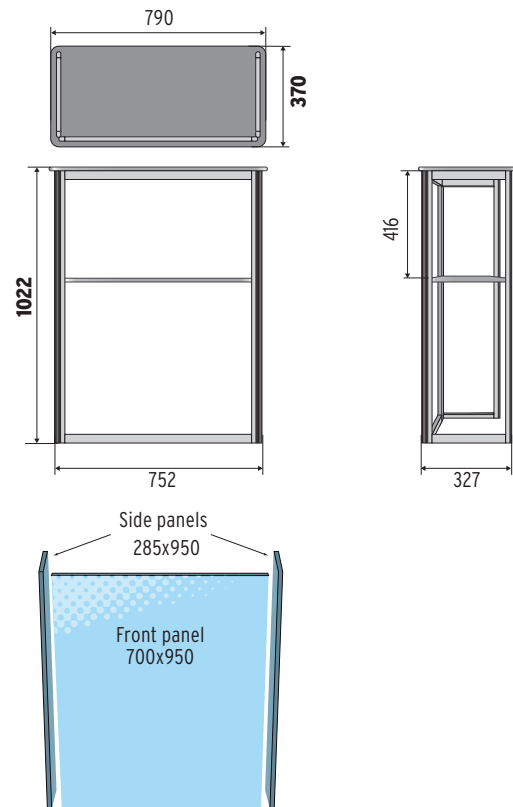

## Soft Image

Product	Panel size front textile	Panel size covered sides	Weight*
<b>Soft Image 2 x 3</b>	1510 x 2240	2150 x 2240	7,0
<b>Soft Image 3 x 3</b>	2240 x 2240	2880 x 2240	9,2
<b>Soft Image 4 x 3</b>	2970 x 2240	3610 x 2240	11,14
<b>Soft Image 5 x 3</b>	3700 x 2240	4340 x 2240	13,6

\*Weight frame only. The above sizes are the actual sizes. As textile is elastic the size may vary.

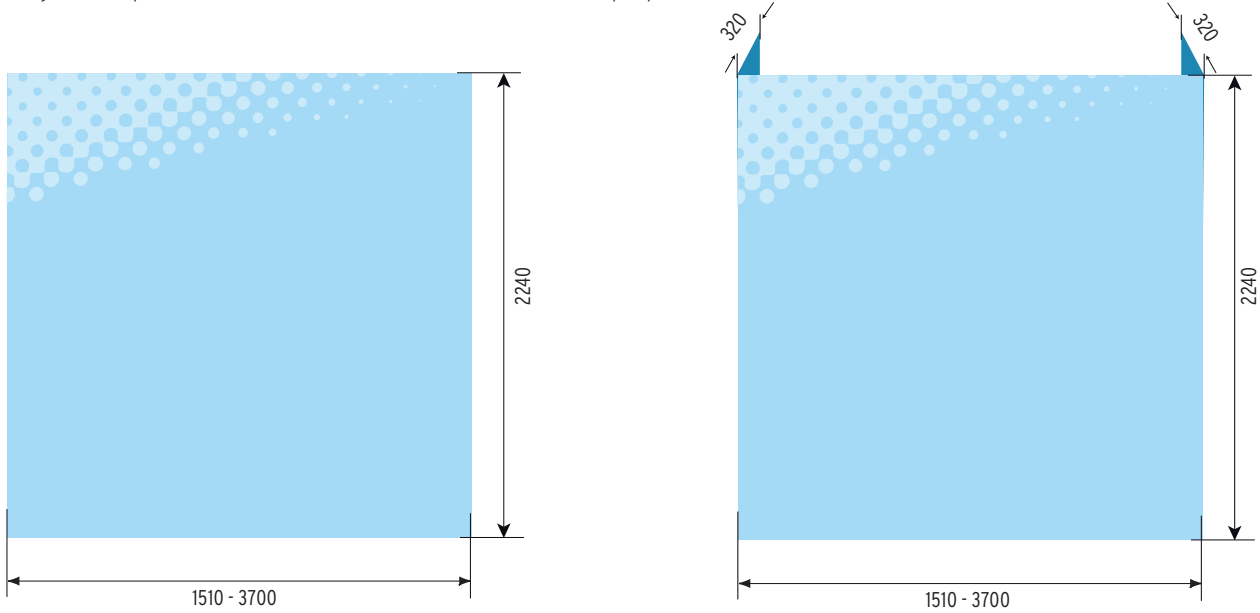

## Soft Image Counter

Product	Size textile front and sides	Weight
<b>Soft Image Counter alt 1</b>	1640 x 990	10,5
<b>Soft Image Counter alt 2</b>	1740 x 990	10,5

The above sizes are the actual sizes. As textile is elastic the size may vary.

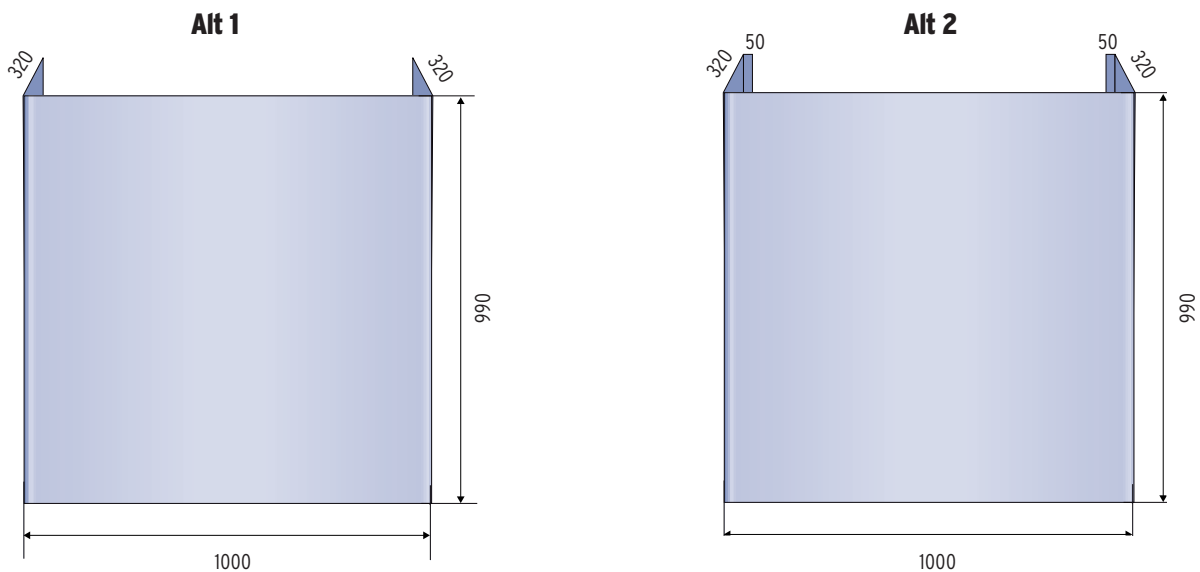

## Info Stand & Portable Table

Product	Max image size	Visible size	Weight
<b>Info Stand - straight</b>	297x420 (landscape A3)	284x420	4,8
<b>Info Stand - angled</b>	210x297 (portrait A4) <i>or</i> 297x210 (landscape A4)	210x297 (portrait A4) <i>or</i> 297x210 (landscape A4)	5,2
<b>Portable Table</b>			10,0

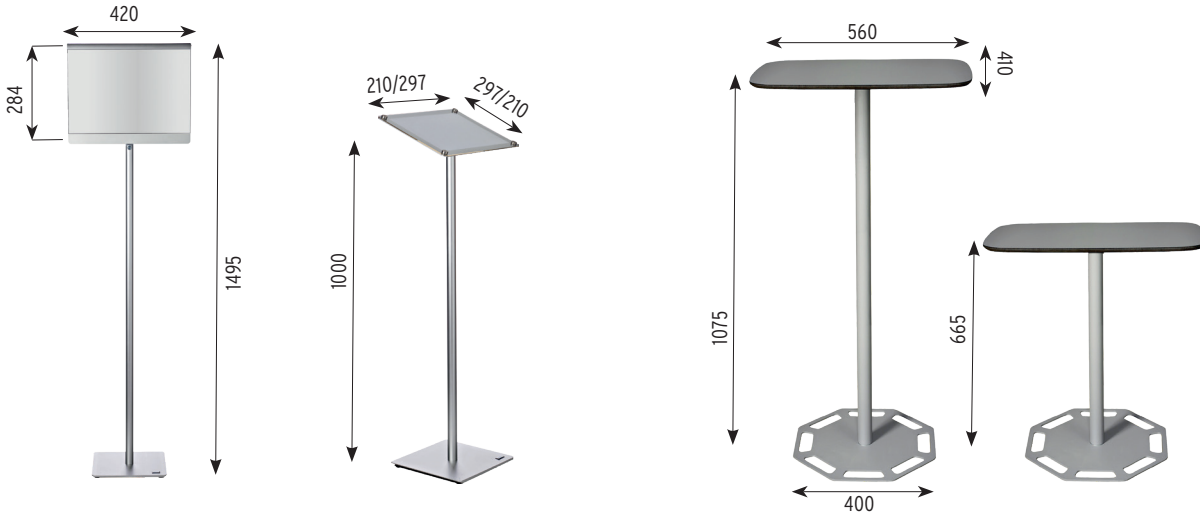

## Brochure Stand

Product	Qty holders	Size of holder	Weight
<b>Brochure Stand with soft bag</b>	4 pcs A4	220 x 330	4,9
<b>Brochure Stand with hard case</b>	4 pcs A4	220 x 330	8,4

## Brochure Stand Double

Product	Qty holders	Size of holders	Weight
<b>Brochure Stand Double with soft bag</b>	5 pcs A4	220 x 330	5,2
<b>Brochure Stand Double with hard case</b>	5 pcs A4	220 x 330	8,7

## Graphic Profile

Product	Max thickness mikron	Weight Kg/m
<b>All versions</b>	800	0,35

VISIT [WWW.EXPOLINC.COM](http://WWW.EXPOLINC.COM) FOR SET-UP MOVIES AND DOWNLOADS



WATCH OUR SET-UP MOVIES



HEAD OFFICE SWEDEN: Expolinc AB, Archimedesvägen 6, SE-168 67 BROMMA. Tel +46-8-54644400. info@expolinc.se, www.expolinc.com  
GERMANY, SWITZERLAND: Expolinc GmbH, Schulze-Delitzsch-Str. 8, 68542 HEDDESHEIM. Tel +49(0)6203 938480, info@expolinc.de, www.expolinc.de  
U S A: Expolinc Co., PO Box 218, 1091 County Road 26, Marengo, OH 43334 TOLL FREE 1-800-319-0025. info@expolinc.us, www.expolinc.us  
AUSTRIA, CZECH REPUBLIC, HUNGARY: Tel: +43 660 644 0701, roland@expolinc.at  
FRANCE: Tel +33 (0) 6 59 47 98 54, denis@expolinc.com